

LARGE DISPLAY

**PANEL METER
MODEL L2Q SERIES**

U0120ML-01

WARNING: ELECTRIC SHOCK HAZARD.

THE HIGH VOLTAGE DC WITHIN THE SWITCHING MODE PSU OF THE L2Q HAS A SLOW DISCHARGE TIME CONSTANT.

IT IS ADVISED THAT THE METER SHOULD BE LEFT FOR AT LEAST 60 SECONDS. AFTER THE MAINS SUPPLY HAS BEEN REMOVED; BEFORE ANY ATTEMPT IS MADE TO REMOVE THE REAR PANEL.

THE METER SHOULD NOT BE OPERATED WITH THE REAR PANEL REMOVED OTHER THAN BY QUALIFIED SERVICE PERSONNEL.

REV	ECONO	DATE	BY	CHK.
C	U0120	21 JUN 90	<i>M</i>	<i>ES</i>

L2Q OWNERS HANDBOOK

CONTENTS:

	PAGE
1. <u>INTRODUCTION</u>	2
2. KEY TO TYPE NOS.....	3
<u>MAIN ASSEMBLY</u>	
3. SPECIFICATION.....	4
4. MECHANICAL ASSEMBLY AND INSTALLATION.....	5
5. POWER AND SIGNAL INPUT CONNECTIONS.....	6
6. CONFIGURATION PROCEDURE.....	7
7. TESTS AND DIAGNOSTICS.....	9
8. DRAWINGS.....	9
8.1 Voltmeter Card Schematic.....	10
8.2 Voltmeter Card Assembly.....	11
8.3 4 DIGIT Display Card Schematic.....	12
8.4 4 DIGIT Display Card Assembly.....	13
8.5 Power Supply Schematic.....	14
8.6 Power Supply Assembly.....	15
8.7 Case Dimensions.....	16
8.8 Mechanical Assembly.....	17
8.9 IP 65 Case Option.....	18
<u>SIGNAL CONDITIONER</u>	
9. SPECIFICATIONS.....	19
10. INSTALLATION INTO MAIN ASSEMBLY.....	20
11. TESTS AND DIAGNOSTICS.....	21
12. CONFIGURATION PROCEDURE.....	22
13. CALIBRATION PROCEDURE.....	23

1) INTRODUCTION

The L2 Product family consists of a range of 4 or 6 digit 57mm (2 1/4") high LED meters.

They can be panel mounted, wall mounted, free standing or hung from a suitable support. They are legible up to a distance of 15 metres minimum.

The L2 will accept any mains voltage between 95 and 265v AC at any frequency between 45 and 440 Hz. as standard.

(Please consult the factory for any other Input Power Requirements)

Green LED displays are available as an Option.

The L2Q Host Meter accepts the full range of Newport QUANTA Input signal conditioner cards. This gives a wide choice of measurement capability including:

- AC/DC Voltage and Current
- True RMS Voltage and Current
- Strain Gauge
- Thermocouple
- Resistance Thermometer
- Process Loop
- Frequency

Full specifications of the above signal conditioners appear in the relevant QUANTA option Handbook.

Various other Host Meters are currently available with further variants currently under development.

These include real time clocks, frequency/ratemeters, process loop receivers, serial and parallel data displays etc.

2) KEY TO TYPE NOS.

A complete description of a L2Q meter is composed as shown in the table below.

L2Q	
PRODUCT FAMILY _____	
DISPLAY COLOUR _____	
*R. (Red high efficiency LED)	
G. (Green high efficiency LED)	
ANALOG OUTPUT OPTION (BA01) _____	
*0. None	
1. 0-5v	
2. 0-10v	
3. 0-1mA	
4. 0-20mA	
SIGNAL CONDITIONER OPTION _____	
A. DC Voltage	
B. DC Current	
C. AC Voltage	
D. AC Current	
F. True RMS Voltage	
G. True RMS Current	
H. Frequency/Rate	
J. Type J Thermocouple	
K. Type K Thermocouple	
T. Type T Thermocouple	
M. RTD Normal Resolution	
N. RTD High Resolution	
O. 2 or 4 wire Resistance	
P. Process Loop	
Q. Square Root Extractor	
E. Process Loop + Excitation	
S. Strain Gauge/mV Meter	
L. LVDT	
MOUNTING OPTIONS _____	
*0 Standard Panel mounting	
A7 Wall mounting brackets	
A8 Hanging brackets	
A9 Dust/water resistant housing to IP65. (NEMA)	

NOTE: *denotes factory default configuration

i.e. A L2QR0DA8 Meter would be a AC Ammeter with Red Display , no Analog output and supplied with hanging brackets.

MAIN ASSEMBLY

3). SPECIFICATION.

CONVERSION TECHNIQUE	: Dual slope integration Auto Zero Average Reading
INTEGRATION PERIOD	: 100mS.
READ RATE	: 2.5 per Sec.
CRYSTAL OSCILLATOR FREQUENCY	: 100 KHz.
DISPLAY TYPE	: RED High Efficiency LED 7 segment 57mm (2 1/4") (Green LED Display Optional)
RANGE	: -9999 to +9999 (-1999 to +1999 Optional)
POLARITY	: LED BAR
OVERLOAD/ALARM	: LED BLOCK (lights above 9999 on 4 dig. Display flashes above x2 overload on 4 dig. and 1999 on 3 1/2 dig.)
DECIMAL POINTS	: Internally Selectable
MAINS AC INPUT FREQUENCY	: 95 to 265v : 45 to 440 Hz.
POWER	: 10 WATTS
FUSE	: Wickmann 19195 315 mA (Anti-surge)
INPUT OPTIONS	: Please consult the factory for any special input Power requirements.
OPERATING TEMP.	: 0 to 50 deg.C (Reduced to 40 deg C if maximum display brightness is selected see sec.6.5)
STORAGE TEMP.	: -20 to 85 deg.C
HUMIDITY	: 85% non-condensing
RFI	: VDE 0871 Level B
DUST/WATER PROOF	: IP 65 (Optional)
CASE SIZE	: 264 x 120 x 112mm
PANEL CUT-OUT	: 258 x 114mm
CASE DEPTH	: 107mm Behind Bezel
MATERIAL	: Aluminium Extrusion. Black Anodised Finish
WEIGHT	: 2.5 Kg
MAINS CONNECTOR	: IEC Fused Connector
SIGNAL CONNECTOR	: 9 Pin Sub-miniature D type plus Special thermo-couple matching input socket for signal conditioner types J,K and T.

ANALOG OUTPUT
OPTION

: 0 to 10v/0 to 1 mA/4 to 20mA monitor of meter
reading for re-transmission.

4) MECHANICAL ASSEMBLY AND INSTALLATION.

PANEL MOUNTING PROCEDURE

- 4.1) Remove the Mains and Signal Connectors, if fitted from the rear panel.
- 4.2) Remove the adjustment hole blanking plug from the R.H. Side Panel.
- 4.3) Place the meter into the panel cut-out (258 x 114mm)
- 4.4) Place the two Panel mounting clamps into the locating slots on the case.
NOTE: Two clamps are supplied and should be installed one at each side-centre.

The clamps should be installed such that the **locking ridge** faces forwards and hence engages in the internal groove in the case slots; when the clamps are tightened.
- 4.5) Tighten the two clamp jacking screws until the meter is held securely, using a 5mm Hex. drive.
- 4.6) Replace the adjustment hole blanking plug and rear panel connections if appropriate.

WALL MOUNTING/HANGING BRACKET INSTALLATION.

- 4.7) Brackets for Wall mounting or hanging are available as options and are secured to the L2Q meter Body by the existing Side Panel screws.
- 4.8) Remove the **two top** cross-head screws from **both sides** for the hanging brackets OR the **two rear** cross-head screws from **both sides** for the wall mounting brackets.
- 4.9) Place the appropriate brackets in position and replace the side panel cross-head screws.

5) POWER AND SIGNAL INPUT CONNECTIONS.

5.1) AC MAINS : IEC Fused Connector (with spare fuse)

AC POWER CONNECTIONS		
AC POWER	WIRE COLOUR	
	EUROPE	USA
AC POWER HI	BROWN	BLACK
AC POWER LO	BLUE	WHITE
AC POWER GND	GREEN/YELLOW	GREEN

5.2) SIGNAL CONNECTIONS:

SIGNAL

PIN NO.

(9 way D type)

ANALOG OUTPUT.

(When fitted)

Analog O/P+

4

Analog O/P-

9

Chassis *SEE NOTE

5

* MUST NOT BE USED AS A SAFETY EARTH CONNECTION.

SIGNAL CONDITIONER TYPE.

A,C,F,H,P	Signal High	1
	Signal Low	6
B,D,G	Signal High	1,2
	Signal Low	6,7
E,Q	Signal High	1
	Signal Common	6
	Excitation +	2
L,M,O,R,S	Signal High	1
	Excitation +	2
	Signal Low	6
	Excitation -	7
N	High	6
	Wiper	1
	Low	2
J,K,T	Signal +	Auxilliary Thermocouple Connector
	Signal -	

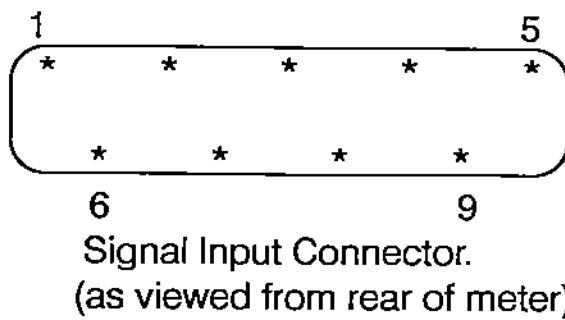

6) CONFIGURATION PROCEDURE.

6.1) REMOVING THE L2Q FROM ITS CASE

1. Remove the rear panel (ten retaining screws)
2. Remove the right hand side plate (four retaining screws)
3. The L2Q can now be slide out from its case
4. To assemble reverse the procedure

6.2) 3 1/2 or 4 DIGIT. RESOLUTION

Remove all Jumpers from switches S1 to S4 on the Display card (U0066AY). Select the required Meter resolution from Table 1.

9999	1999
S1 A	S1 B
S2 A	S2 B
S3 A	S3 B
S4 A	S4 B

Table 1. Selection of 3 1/2 or 4 Digit Resolution.

6.3) OVER-RANGE INDICATOR INHIBIT.

If the Meter is configured as a type L2Q (3 1/2 digit.), open solder switch D on the display assembly (U0066).

6.4) REF VOLTAGE

Remove all Jumpers from switches S1,S2 and S3 on the Voltmeter card (U0065AY).

If the Meter is a 3 1/2 Digit. select a 1v Reference Voltage. (SEE TABLE 3)

If the Meter is a 4 Digit the reference voltage is dependant upon the type of Quanta Plug-in used. Check which is required in Table 2 below.

1v REF.	2v REF.
A	P
B	S
C or D (except 5A Range DCR7)	E
F or G (except 5A Range-GCR7)	C or D (5A Range i.e. DCR7 only)
H	F or G (5A Range i.e. GCR7 only)
J,K,T	
M,R	
N	
O	
Q	

Table 2. Requirement for 1v or 2v Ref. (4 Digit. only)

Select the required Reference Voltage as shown in Table 3.

1V	2V
S1 CLOSED	S1 OPEN

Table 3. Selection of 1v or 2v Ref. Voltage

6.4) DECIMAL POINT

Select the required decimal point from Table 4.

	4 Dig.	3 1/2Dig.
S3 A	999.9	1999.
S3 B	99.99	199.9
S3 C	9.999	19.99
S3 D	9999	1.999

Table 4. D.P. Selection

6.5) DISPLAY BRIGHTNESS.

Select the required Display brightness by referring to Table 5.

NORMAL	HIGH	LOW
S2-B	S2-A	S2-OPEN

Table 5. Selection of Display brightness.

7) TESTS AND DIAGNOSTICS.

The L2Q Main Assembly is designed to function with a signal conditioner board as a minimum configuration.

There is no provision for testing a Main Assembly in isolation.

SELECT DECIMAL POINT		
4 DIGIT	1/2 DIGIT	
S3 A	999.9 1999.	
S3 B	99.99 199.9	
S3 C	9.999 19.99	
S3 D	9999 1.999	
S3 OPEN	9999 1999	
SELECT REFERENCE VOLTS		
1V REF	2V REF	
S1 A	—	
SELECT BRIGHTNESS		
LOW	NORMAL	HIGH
S2 OPEN	S2 B	S2 A

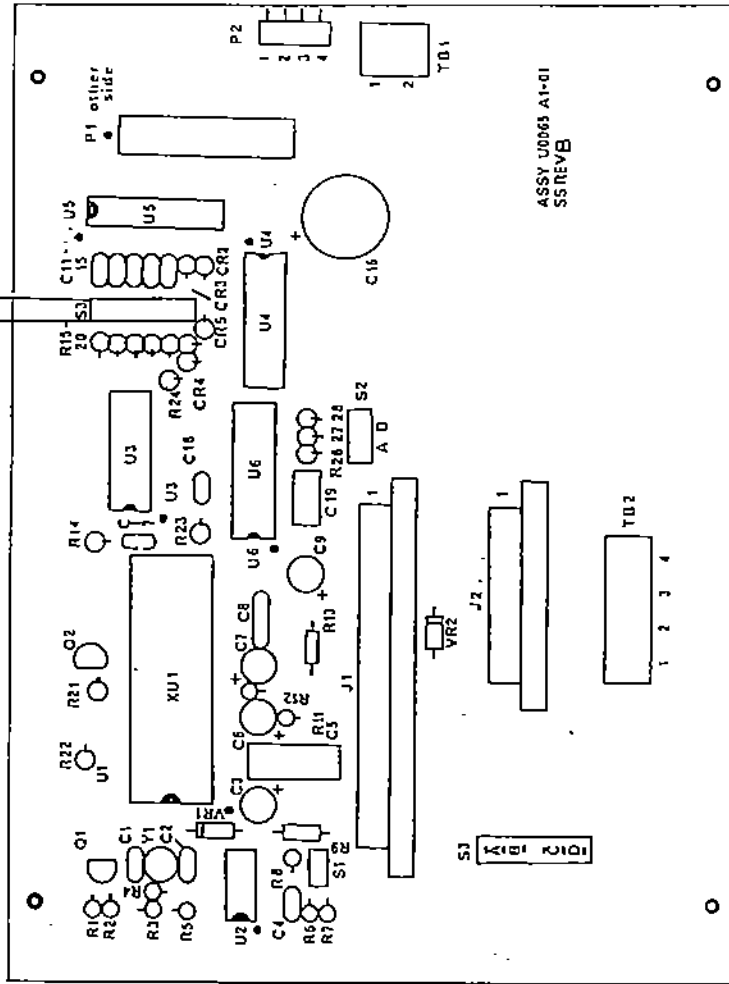

Y ←

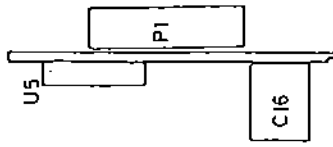

VIEW FROM 'Y'
SHOWING P1 ON
TRACKSIDE OF BOARD

ASSY U0065 A1-01
S5 REV B

DWG NO.
U0065AY-01 B

8.2 VOLTMETER CARD ASSEMBLY.

VIA WITH 0.014" Y-AXIS.
SCALE NONE

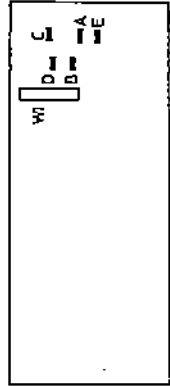
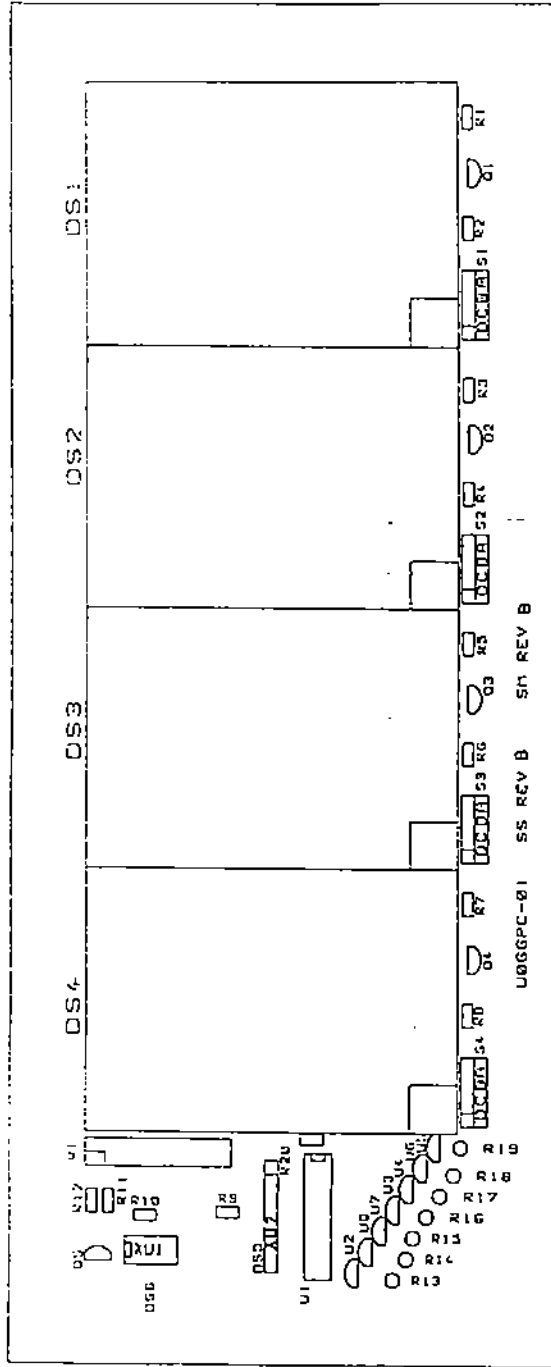
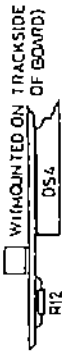

PCB VIEWED FROM THE
TRACKSIDE SHOWING SOLDER
SWITCH POSITION

SELECTION OF 3] OR 4-DIGIT RESOLUTION

DWG No.
U0066AY-01 B

8.4 DISPLAY CARD ASSEMBLY.

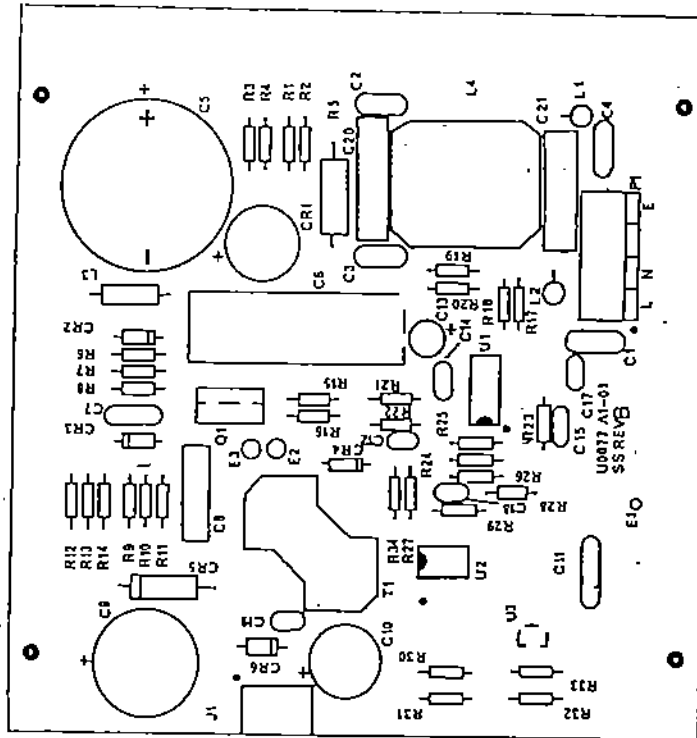

DWG No.
U0077AY-01 B

NOTE CONNECT THE RED SLEEVED FLYING LEAD FROM T1 TO E2 (BLACK SLEEVED TO E3)

8.6 POWER SUPPLY ASSEMBLY.

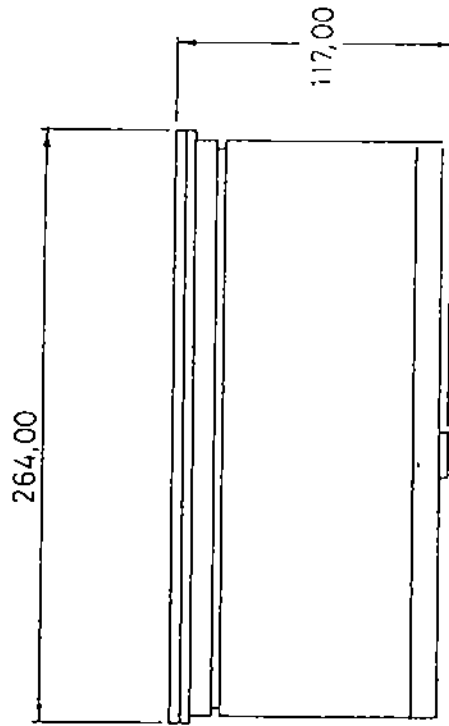

TOP VIEW

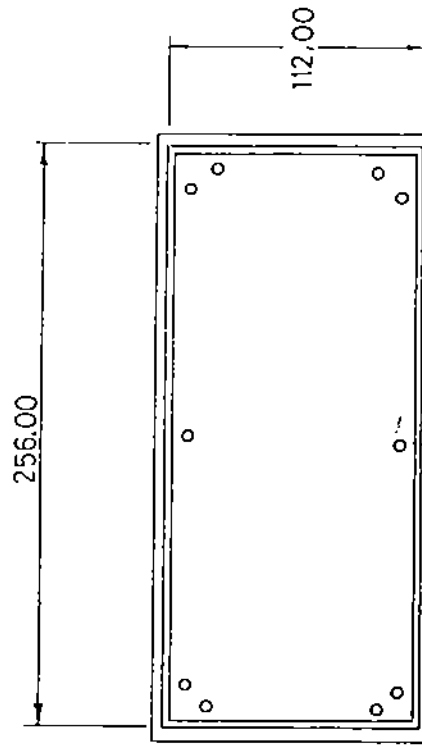

REAR VIEW

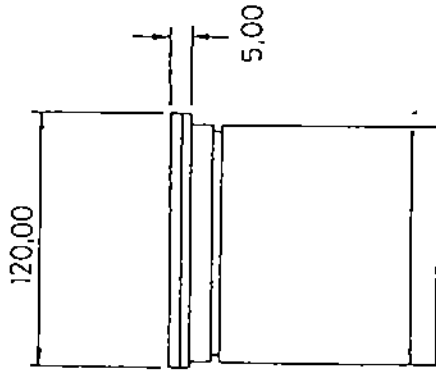

SIDE VIEW

Note
Dimensions are
in millimeters

PANEL THICKNESS
14,00 MAX

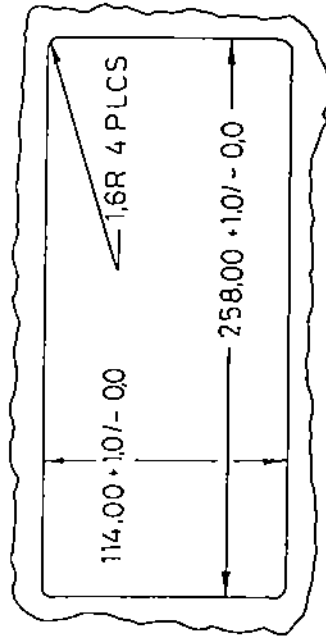

PANEL CUTOUT

DWG No.
U0143ML-01

8.7 CASE DIMENSIONS

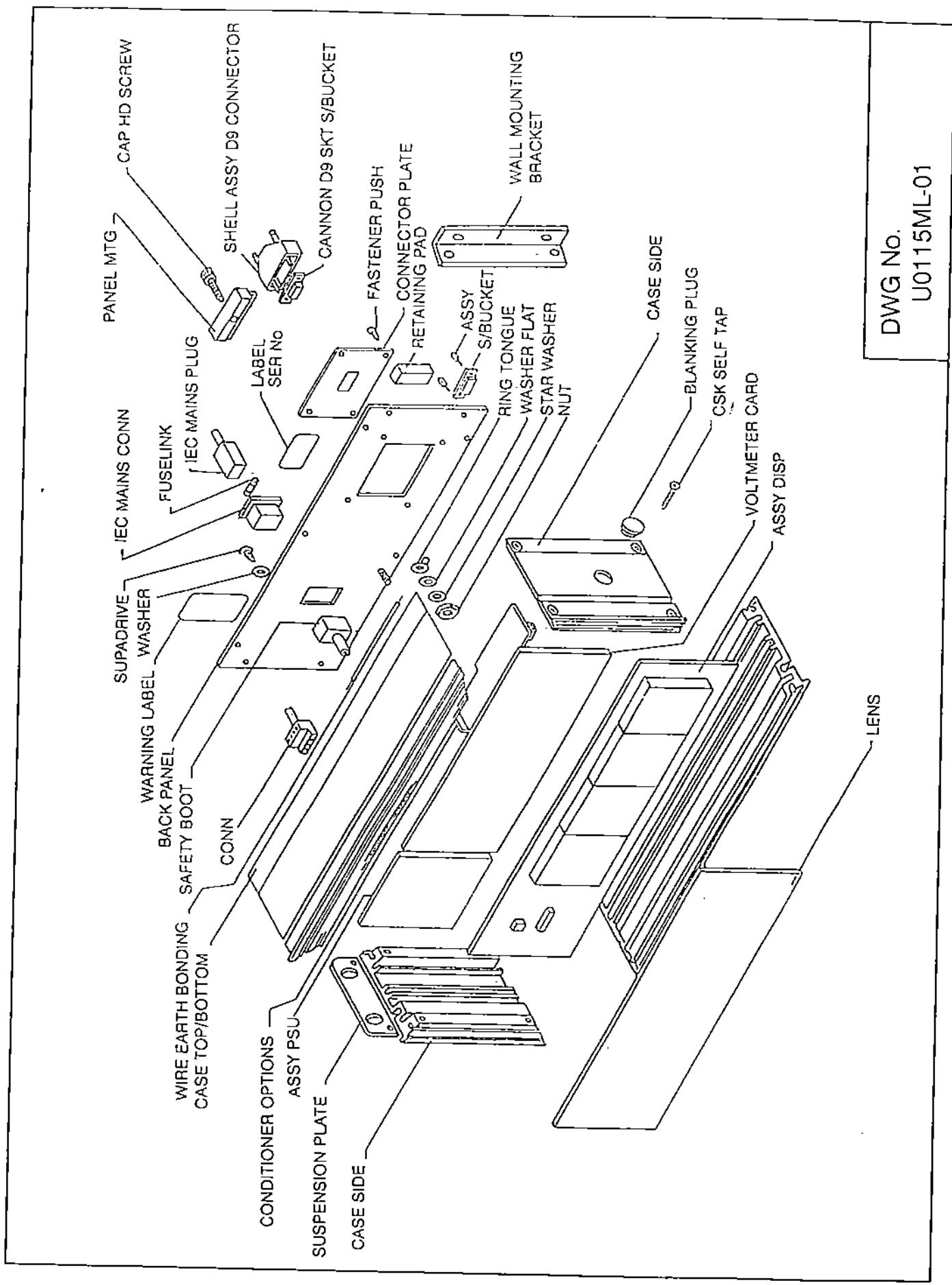

DWG No.
 U0115ML-01

8.8 MECHANICAL ASSEMBLY

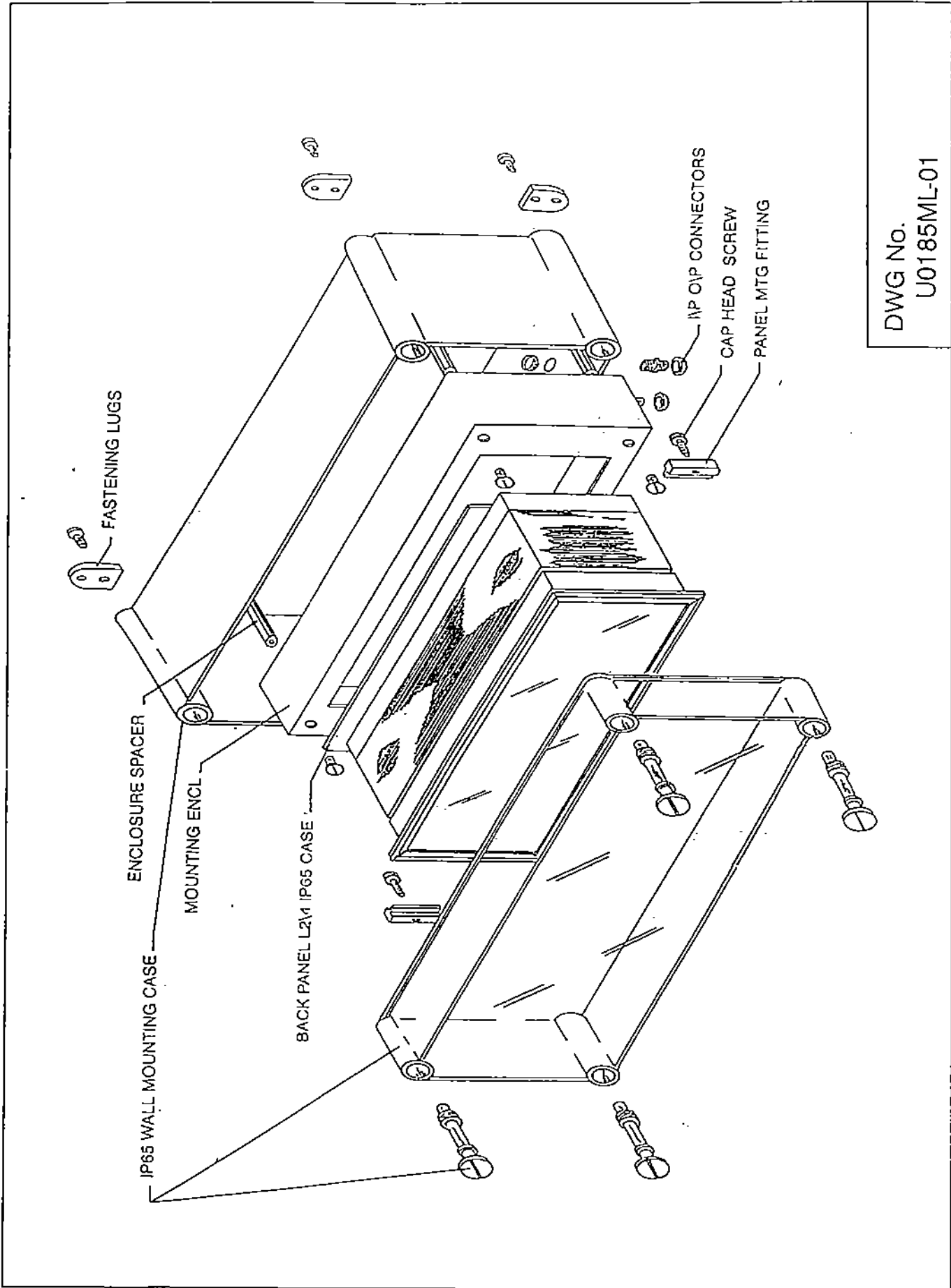

DWG No.
 U0185ML-01

8.9 IP 65 CASE OPTION

SIGNAL CONDITIONER.

9) SPECIFICATIONS

The specification is as per the equivalent "QUANTA" range Meter. Refer to Sec.17 of the relevant Handbook supplied for details.

Note the signal connector limits the signal common mode voltage to 130 Volts per IEC spacing.

NOTES: In the QUANTA Handbook

1. The signal conditioner card is identified as BSCX where X is the L2Q signal conditioner option. (See table on sheet 3)
2. Where there is a differential between Q2000 and Q9000 specifications it should be noted that:-

4 Digit is equivalent to **Q9000**

and

3 1/2 Digit is equivalent to **Q2000**

(With one exception that the 3 1/2 Digit. has a x5 improvement in its zero temperature coefficient compared with the Q2000 Meter)

10) INSTALLATION INTO MAIN ASSEMBLY.

10.1) Remove the mains and signal connectors from the rear panel, if fitted.

WARNING: ELECTRIC SHOCK HAZARD.

THE HIGH VOLTAGE DC WITHIN THE SWITCHING MODE PSU OF THE L2Q HAS A SLOW DISCHARGE TIME CONSTANT. IT IS ADVISED THAT THE METER SHOULD BE LEFT FOR AT LEAST 60 SECS. AFTER THE MAINS SUPPLY HAS BEEN REMOVED; BEFORE ANY ATTEMPT IS MADE TO REMOVE THE REAR PANEL.

THE METER SHOULD NOT BE OPERATED WITH THE REAR PANEL REMOVED OTHER THAN BY QUALIFIED SERVICE PERSONNEL.

10.2) Remove the 10 off cross-head screws retaining the rear panel to the case body.

10.3) Carefully pivot the rear panel about its lower-edge; to allow access.

10.4) Install the required QUANTA signal conditioner card into its mating socket on the Voltmeter card (UOO65AY)- See Mechanical Assembly Drawing (UOO85ML)

10.5) Make the necessary connections between the signal conditioner card and the rear panel D type connector.

Refer to Section 18 (Signal Input Connections) of the appropriate QUANTA Handbook and Section 5 of this Handbook, for wiring details.

See also FIG.10.1 Overleaf for Signal Conditioner Terminal Identification.

10.6) Re-position the rear panel onto the case Assembly and replace the cross-head retaining screws.

FIG 10.1 SIGNAL CONDITIONER TERMINAL IDENTIFICATION.
 (Voltmeter UOO65+Signal Conditioner Cards as viewed from rear of L2Q Meter.)

TYPES:A,B,C,D,E
 F,G,H,J,K
 N,P,T,Q,R

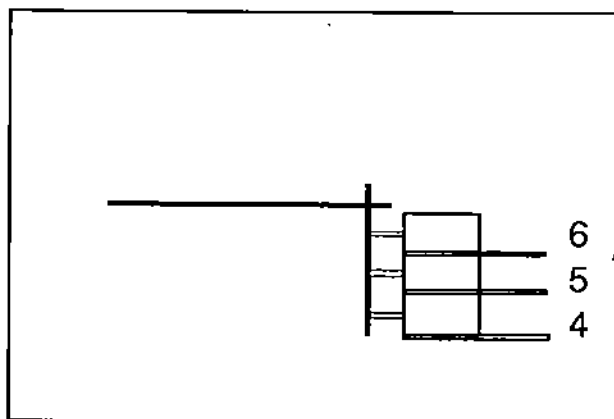

TYPES:S,R,M,O,L

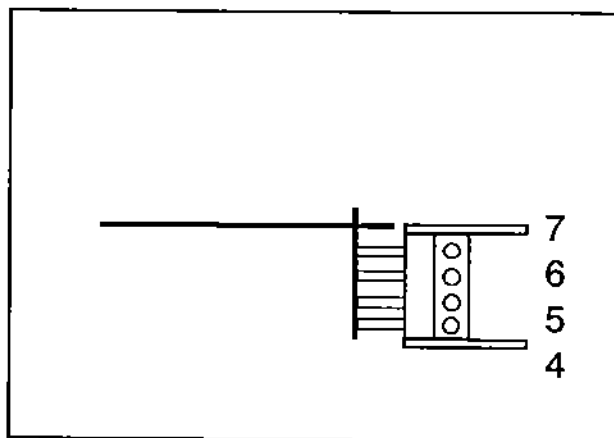

11) TESTS AND DIAGNOSTICS.

The signal conditioner card options are designed to function with a L2Q Main Assembly as a minimum configuration. There is no provision for testing a signal conditioner card in isolation.

12) CONFIGURATION PROCEDURE.

The configuration procedure for a L2Q signal conditioner card remains exactly as per the equivalent QUANTA Meter.

A copy of the relevant QUANTA Handbook is shipped with every L2Q supplied.

Reference should be made to section 20 (CONFIGURATION PROCEDURE) and section 21 (CONFIGURATION CHARTS) of the QUANTA Handbook for Configuration details.

NOTES: In the QUANTA Handbook

1. The Signal Conditioner card is identified as BSCX where X is the L2Q Signal Conditioner Option.
2. Where there is a differential between the Q2000 and Q9000 Configuration it should be noted that:-

L2Q 4 Digit is equivalent to Q9000
and
L2Q 3 1/2 Digit is equivalent to Q2000.

13) CALIBRATION PROCEDURE.

The Calibration Procedure for a L2Q Meter remains exactly as per the equivalent QUANTA Meter.

A copy of the relevant QUANTA Handbook is shipped with every L2Q supplied.

Reference should be made to Section 22 (Q2000 Calibration) and Section 23 (Q9000 Calibration) of the QUANTA Handbook.

NOTES: IN the QUANTA Handbook

1. The signal Conditioner card is identified as BSCX where X is the L2Q signal Conditioner Option.
2. Where there is a differential between the Q9000 and Q2000 Calibration it should be noted that:

L2Q 4 Digit is equivalent to Q9000

and

L2Q 3 1/2 Digit is equivalent to Q2000.

NOTES

WARRANTY

All products from Newport Electronics are warranted against defective material and workmanship for a period of one (1) year from date of delivery.

We would like to know more about customer needs. Please help us by filling out the warranty card enclosed. In exchange, Newport Electronics will extend this warranty for one (1) additional year.

If the Newport product you have purchased appears to have a defect in material or workmanship or fails during normal use within the warranty period, please contact Newport Electronics INC on 1- 800 - 284 - 4914, if in the USA, or on (0438) 365671 for the UK, and European Headquarters, or call direct to any of our European offices shown on the back of this manual. We will assist you in resolving the problem. If it is necessary to return the product to Newport, please include a note stating: Name, Company, Address, Phone number, and a detailed description of the problem. Also, please indicate that this is a warranty repair. The sender is responsible for shipping charges, freight, insurance and proper packaging to prevent breakage in transit.

Newport's warranty does not apply to defects resulting from action of the buyer, such as mishandling, improper interfacing, operation outside of design limits, improper repair, or unauthorised modification.

No other warranties are expressed or implied. Newport Electronics specifically disclaims any implied warranties of merchantability or fitness for a specific purpose. The remedies outlined above are the buyer's only remedies. Newport Electronics will not be liable for direct, indirect, special, incidental or consequential damage whether based on contract, tort or other legal theory.

YOUR LOCAL NEWPORT DISTRIBUTOR IS:

NEWPORT WORLDWIDE ORGANISATION

USA HEAD OFFICE

Newport Electronics, Inc.
2229 South Yale Street
Santa Ana, CA 92704-4426
Phone: (714) 540-4914
FAX: (714) 546-3022

EUROPEAN HEAD OFFICE

Newport Electronics Ltd.
Cavendish Road
Stevenage, Herts
England SG1 2ET
Phone: (0438) 365671
FAX: (0438) 356203
Telex: 826454
(NEWPEL G)

GERMAN FEDERAL REPUBLIC

Newport Electronics GmbH
7269 Deckenpfronn
Gaustasse 28-30
German Federal Republic
Phone: (07056) 3017
FAX: (07056) 8540
Telex: 726157
(NEWPORT D)

BENELUX

Newport Electronics B.V.
Postbus 8034
1180 LA Amstelveen
The Netherlands
Phone: (020) 418405
FAX: (020) 434643
Telex: 11688
(NEWPORT NL)

FRANCE

Newport Electronique S.A.R.L.
9 rue Denis Papin
78190 Trappes
France
Phone: (1) 30.62.14.00
FAX: (1) 30.69.91.20
Telex: 697797

UNITED KINGDOM

Newport Electronics Ltd.
Cavendish Road
Stevenage, Herts
England SG1 2ET
Phone: (0438) 365671
FAX: (0438) 356203
Telex: 826454